



Linisher Installation Manual

808438 - AA362

808439 - AA362W6

808440 - AA362W8

AA362

362 Linishing Attachment
3 Year Limited Warranty

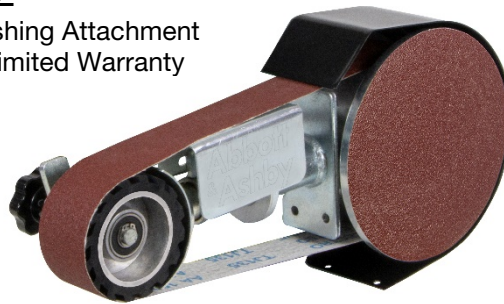

AA362W6

362 Linishing Attachment
with 6" Bench Grinder



AA362W8

362 Linishing Attachment
with 8" Bench Grinder



1. Contents

1. Contents	3
2. Introduction	4
3. Key Features.....	4
4. ISO 7010 Symbols used in this manual.....	5
5. Warnings.....	5
6. Standards and Approvals	7
7. Technical Specifications.....	8
8. Safety Instructions	9
9. Product pieces	10
10. Installation	11
11. Maintenance	17
16. Warranties – Terms and Conditions.....	18

2. Introduction



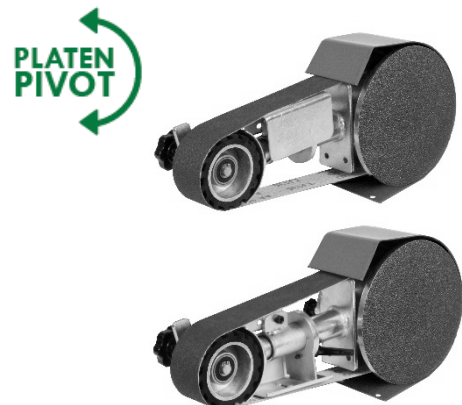
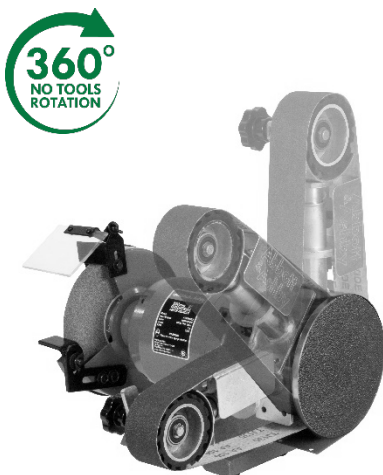

Thank you for purchasing this product which has passed through our extensive quality assurance process. Every care has been taken to ensure that it reaches you in perfect condition.

3. Key Features





- Patent pending design allows for fast changes to the working angle without disassembly in 6° increments
- Top platen can be used for flat surface grinding and can be moved out of the way for convenient free strapping
- Easy belt tracking adjustment knob and lock
- Fast belt changes with patent pending push in push out arm retraction/extension system
- 915 x 50mm (36 x 2") belt
- 178mm (7") diameter disc
- 89mm (3.1/2") contact wheel
- Optional Mitre Table Accessory is also available
- Linishing Attachment fully assembled out of the box











4. ISO 7010 Symbols used in this manual

	Warning - Electrical safety
	Warning – Potential consequences of use outside of intended application(s). Includes environmental condition warnings.
	Mandatory warning
	Warning to disconnect power
	Read carefully

5. Warnings

	Read the manual carefully before starting and retain for future reference. Failure to follow all instructions listed below may result in electric shock, fire and/or serious injury. The term “power tool” in all of the warnings listed below refers to your mains-operated (corded) power tool.
	Prior to starting installation or any maintenance the product must be disconnected from the power supply.
	Always wear eye protection
	<p>ELECTRICAL SAFETY</p> <ol style="list-style-type: none"> Power tool plugs must match the outlet. Never modify the plug in any way. Do not use any adapter plugs with earthed (grounded) power tools. Unmodified plugs and matching outlets will reduce risk of electric shock. Avoid body contact with earthed or grounded surfaces such as pipes, radiators, ranges and refrigerators. There is an increased risk of electric shock if your body is earthed or grounded. Do not expose power tools to rain or wet conditions. Water entering a power tool will increase the risk of electric shock. Do not abuse the cord. Never use the cord for carrying, pulling or unplugging the power tool. Keep cord away from heat, oil, sharp edges or moving parts. Damaged or entangled cords increase the risk of electric shock.

	<p>e. When operating a power tool outdoors, use an extension cord suitable for outdoor use. Use of a cord suitable for outdoor use reduces the risk of electric shock.</p>
	<p>WORK AREA</p> <p>a. Keep work area clean and well lit. Cluttered and dark areas invite accidents.</p> <p>b. Do not operate power tools in explosive atmospheres, such as in the presence of flammable liquids, gases or dust. Power tools create sparks which may ignite the dust or fumes.</p> <p>c. Keep children and bystanders away while operating a power tool. Distractions can cause you to lose control.</p> <p>d. Safe work space. Ensure tool is located in a low traffic area and install safety signage in the area to provide a visual warning to other staff or visitors. It is recommended to mark out a safe work zone to prevent other people from entering when the tool is in use - especially non-qualified users or children.</p> <p>e. Secure the Grinder. It is recommended to secure the grinder to the work bench to prevent unnecessary movement and injury.</p>
	<p>PERSONAL SAFETY</p> <p>a. Stay alert, watch what you are doing and use common sense when operating a power tool. Do not use a power tool while you are tired or under the influence of drugs, alcohol or medication. A moment of inattention while operating power tools may result in serious personal injury.</p> <p>b. Use safety equipment. Always wear eye protection. Safety equipment such as dust mask, non-skid safety shoes, hard hat, or hearing protection used for appropriate conditions will reduce personal injuries.</p> <p>c. Avoid accidental starting. Ensure the switch is in the off-position before plugging in. Carrying power tools with your finger on the switch or plugging in power tools that have the switch on invites accidents.</p> <p>d. Remove any adjusting key or wrench before turning the power tool on. A wrench or a key left attached to a rotating part of the power tool may result in personal injury.</p> <p>e. Do not overreach. Keep proper footing and balance at all times. This enables better control of the power tool in unexpected situations.</p> <p>f. Dress properly. Do not wear loose clothing or jewellery. Keep your hair, clothing and gloves away from moving parts. Loose clothes, jewellery or long hair can be caught in moving parts.</p> <p>g. If devices are provided for the connection of dust extraction and collection facilities, ensure these are connected and properly used. Use of these devices can reduce dust related hazards.</p>
	<p>POWER TOOL USE AND CARE</p> <p>a. Do not force the power tool. Use the correct power tool for your application. The correct power tool will do the job better and safer at the rate for which it was designed.</p> <p>b. Do not use the power tool if the switch does not turn it on and off. Any power tool that cannot be controlled with the switch is dangerous and must be repaired.</p> <p>c. Disconnect the plug from the power source before making any adjustments, changing accessories, or storing power tools. Such preventive safety measures reduce the risk of starting the power tool accidentally.</p> <p>d. Store idle power tools out of the reach of children and do not allow persons unfamiliar with the power tool or these instructions to operate the power tool. Power tools are dangerous in the hands of untrained users.</p> <p>e. Maintain power tools. Check for misalignment or binding of moving parts, breakage of parts and any other condition that may affect the power tools</p>

	<p>operation. If damaged, have the power tool repaired before use. Many accidents are caused by poorly maintained power tools.</p> <p>f. Keep cutting tools sharp and clean. Properly maintained cutting tools with sharp cutting edges are less likely to bind and are easier to control.</p> <p>g. Use the power tool, accessories and tool bits etc., in accordance with these instructions and in the manner intended for the particular type of power tool, taking into account the working conditions and the work to be performed. Use of the power tool for operations different from intended could result in a hazardous situation.</p> <p>h. Qualified User. Ensure only qualified or trained users are allowed to operate the tool.</p>
	<p>SERVICE</p> <p>a. Have your power tool serviced by a qualified repair person using only identical replacement parts. This will ensure that the safety of the power tool is maintained.</p>
	<p>Any changes or modification to the wiring must be carried out by suitably qualified personnel.</p>
	<p>A qualified electrician should correctly size and install residual current devices to protect the power supply. The fitment of additional surge protection is recommended.</p>
	<p>This appliance is not intended for use by persons (including children) with reduced physical, sensory or mental capabilities, or lack of experience and knowledge, unless they have been given supervision or instruction concerning use of the appliance by a person responsible for their safety. Children should be supervised to ensure that they do not play with the appliance.</p>
	<p>Ensure that the installation will comply with all applicable local regulations.</p>

6. Standards and Approvals

	<p>CTick – ACN002 123 337</p>
<p>Patent Pending</p>	<p>2020902087</p>

7. Technical Specifications

AA362 Linisher	
Bench Grinder Capacity	6" (150mm) 8" (200mm) 10" (250mm) Minimum motor of 1/3 HP (248W) Shaft size – 12mm (½") or 16mm (5/8") Trade/factory bench grinder – Perfect for A&A Bench Grinders
Linishing surface	Belt –915mm x 50mm (36" x 2") Disc –178mm (7") Contact Wheel – 89mm (3 ½")
WEIGHT	5kg

AA362W6 6" Industrial Bench Grinder and AA362 Linisher	
RPM no load speed	2880
WHEEL SIZE	150 x 25 x 12mm
AMPS	1.8
INPUT/OUTPUT	420W / 280W
WEIGHT	15kg
WHEEL GRIT	60 Medium

AA362W8 8" Industrial Bench Grinder and AA362 Linisher	
RPM no load speed	2880
WHEEL SIZE	200 x 25 x 16mm
AMPS	3.8
INPUT/OUTPUT	900W / 600W
WEIGHT	24kg
WHEEL GRIT	60 Medium

8. Safety Instructions

Protect yourself and others by observing all safety information, warnings, and cautions. Failure to comply with instructions could result in personal injury and/or damage to product or property.

Additional safety rules for Bench Grinders - Wheel

- a. Ensure that the power tool is disconnected from the mains supply when not in use, before servicing, lubricating or making adjustments and when changing accessories such as grinding wheels.
- b. Always use the correct type of grinding wheel for the type of operation to be carried out and the material being machined. Do not use a grinding wheel as a cutting disc.
- c. Only use grinding wheels that are in good condition. This will improve grinding and reduce the load on the machine ensuring a longer life of the grinding wheel and the machine.
- d. Never use damaged grinding wheels. Grinding wheels that are cracked, chipped or worn could shatter causing injury to the operator and bystanders and damage to the machine.
- e. Do not use grinding wheels that are larger than specified, only use grinding wheels that are rated for the machine. The rotational speed shown on the grinding wheel should always be HIGHER than the rotational speed of the machine.
- f. Always fit the blotter or paper washers on either side of the grinding wheel if not already fitted to the grinding wheel.
- g. When fitting a new wheel ensure blotters are in place, fit concave side of washers to face the wheel and tighten the lock nut firmly.
- h. Do not over tighten (over tightening can crack a grinding wheel).
- i. Do not attempt to modify the machine or its accessories in any way.
- j. Do not use excessive force on the grinding wheel. Only use gradual pressure as this will reduce the wear on the bench grinder and grinding wheels and increase its efficiency and operating life.
- k. Use approved safety glasses or goggles, face mask and if being used for an extended period wear ear defenders.
- l. Do not start the machine with the work piece in contact with the grinding wheel or before checking the position of the tool rest.
- m. Never apply the work piece to the side of the grinding wheel, this could cause the grinding wheel to shatter.
- n. Keep guards in place and in good working order. With the machine disconnected from the mains supply check that the guards are secure and fitted correctly.
- o. Always keep the tool rest as close to the grinding wheel as possible. The gap between the tool rest and the grinding wheel should be no more than 2mm.
- p. Do not attempt to grind objects that are too small to hold safely.
- q. Do not use the work piece to slow down the grinding wheel once the machine has been switched off.

Additional safety rules for Bench Grinders - Linisher

- a. Be aware of belt movement and your positioning when grinding. Where possible avoid positioning your body where the grinding belt/disc/wheel is moving towards you, position your body slightly to the side to ensure no material or debris is thrown towards you.
- b. Understand your application and use the correct grit and material belt/disc to suit
- c. Ensure that belt and disc in use is not damaged and if so replace before use. Replacement belts usually have a direction indicator on the inside, ensure the belt is installed correctly with the direction indicator following the movement direction of the tool.
- d. It is recommended to use the guard to lessen the chances of accidents or injury
- e. Ensure the tool is in full operation before you commence the task. Do not hold the material against the belt/disc while the tool is turned "on". Ensure a firm grip is maintained on the material, avoid unnatural hand positions as this can result in sprains, slippage or accidental contact with the sanding surface. Do not attempt to grind objects that are too small to hold safely.

9. Product pieces

AA362W6 & AA362W8 (BENCH GRINDER)

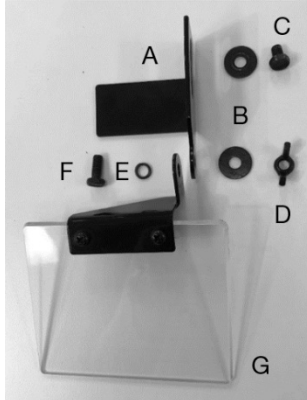

EYESHIELD:

- A) Bracket
- B) 2 x Washers
- C) Short Fastener
- D) Wing Nut
- E) Spring Washer
- F) Long Fastener
- G) Eye Shield

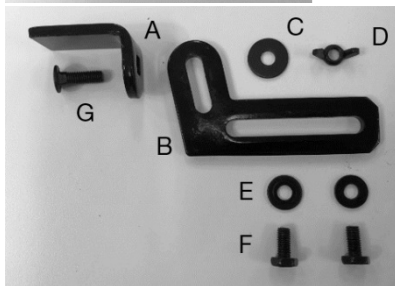

TOOL REST:

- A) Tool Rest
- B) Bracket
- C) 3 x Washers
- D) Wing Nut
- E) 2 x Short Fasteners
- F) Long Fastener

AA362, AA362W6, AA362W8 (LINISHING ATTACHMENT)

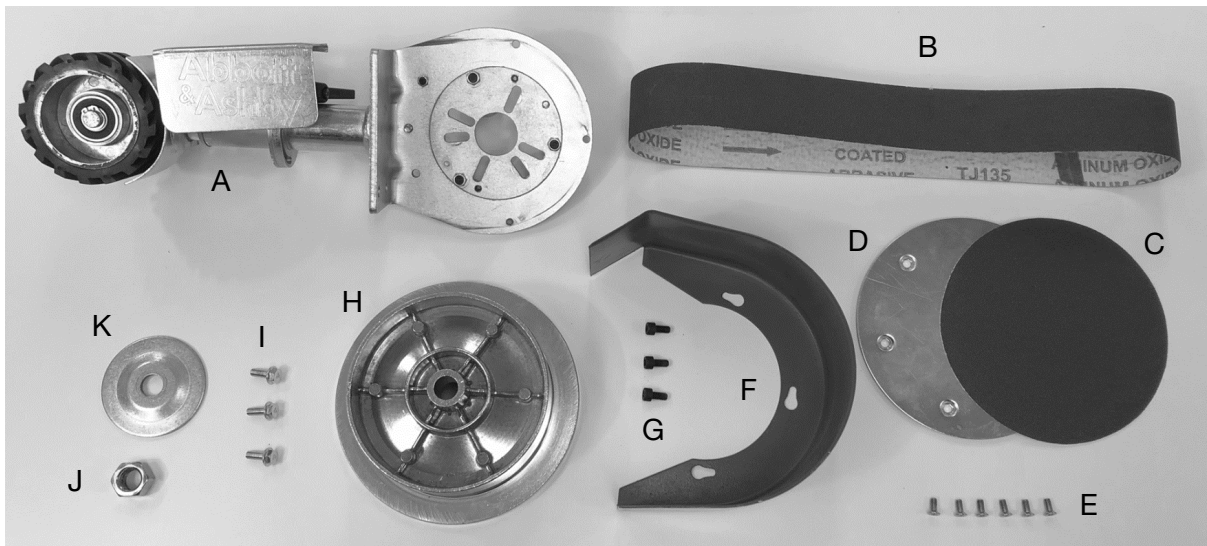

TOOL REST:

- A) Main Bracket
- B) Linishing Belt
- C) Abrasive Disc
- D) Backing Plate
- E) 6 x Fasteners for backing plate
- F) Linishing Guard
- G) 3 x cap screws for guard
- H) Drive Pulley
- I) 3 x 6x20mm fasteners for main bracket
- J) 16mm Nut
- K) Washer

10. Installation

STEPS ONLY REQUIRED FOR INSTALLING ABBOTT & ASHBY AA362 LINISHING ATTACHMENT TO AN EXISTING BENCH GRINDER



Remove the grinding wheel and guard off the side of the bench grinder that you would like to install the linishing attachment to. Keep the original nut and washer holding the grinding wheel in place

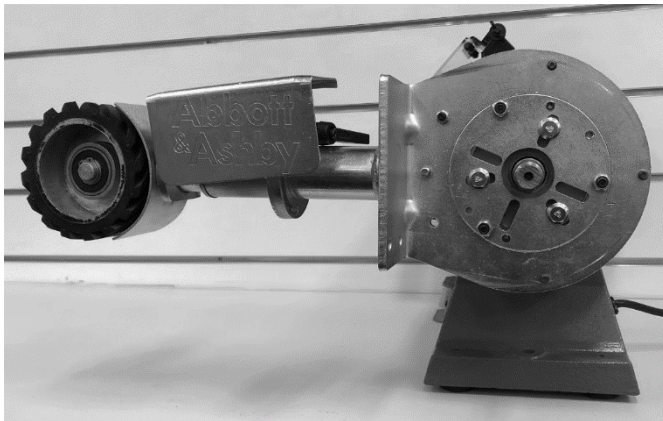

Install the Main Bracket (A) to the Grinder, using the 3 x 6x20mm locking fasteners (I)

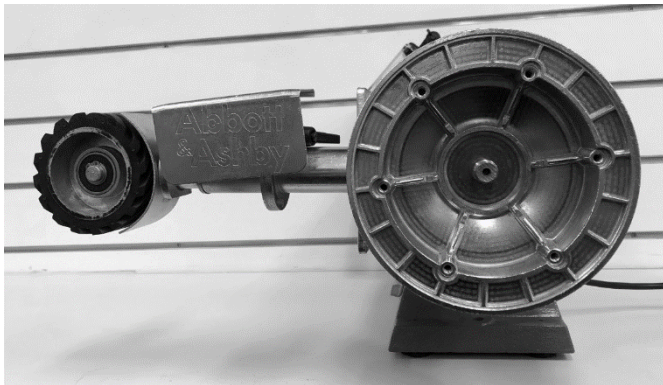

Place the Drive Pulley (H) onto the shaft of the bench grinder if it is a 16mm dia shaft. If the bench grinder has a smaller 12mm shaft you will need to insert the bush (not pictured) to the shaft and then place the drive pulley onto the shaft to ensure there is a snug fit.

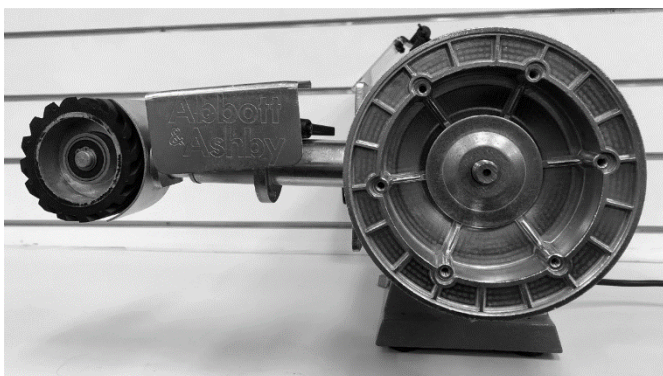

Place the washer (K) over the shaft onto the drive pulley

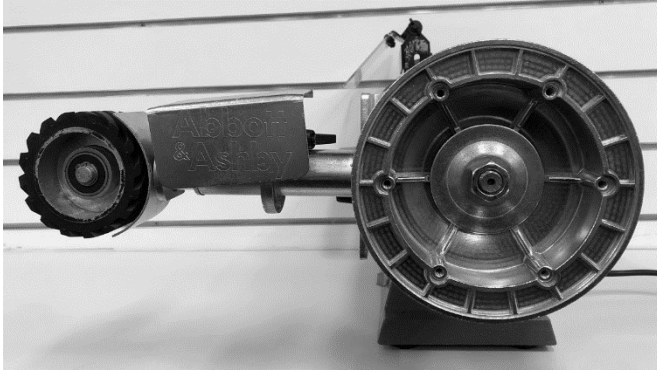

Place the nut (J) over the washer and secure onto the shaft

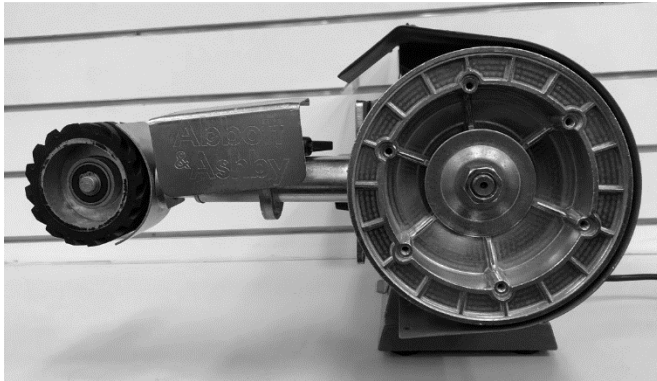

Install the guard (F) over the assembly and tighten the 3 x 6mm cap screws (G)

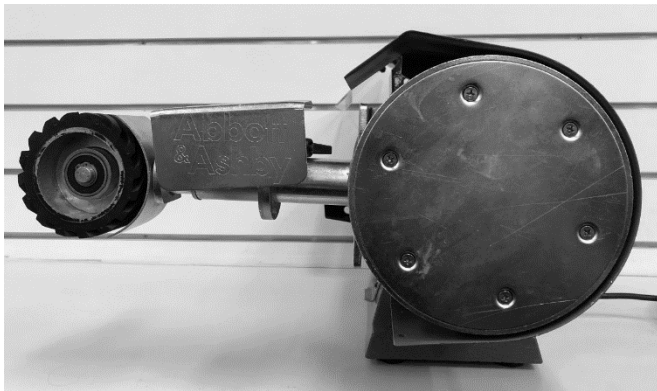
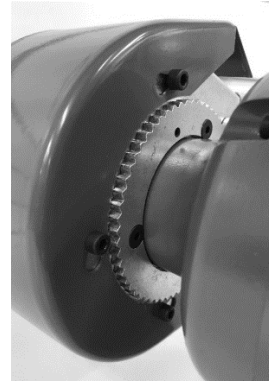

Install the backing plate (D) to the drive pulley with the 6 x fasteners (E)



Attach the abrasive disc (C) to the backing plate. Hold firmly for a few seconds to ensure the adhesive activates.

STEPS REQUIRED FOR AA362W6 AND AA362W8 COMPLETE UNITS

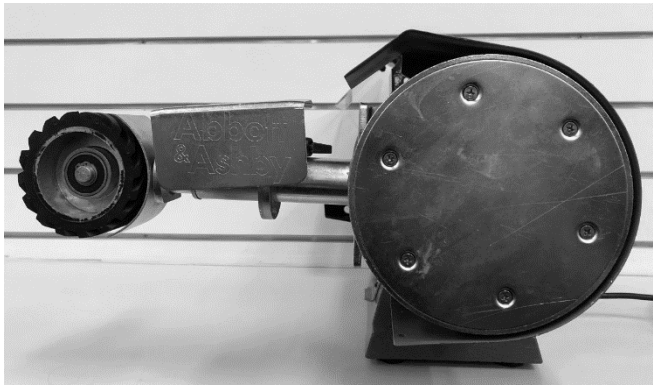

Install the guard (F) over the assembly and tighten the 3 x cap screw (G)

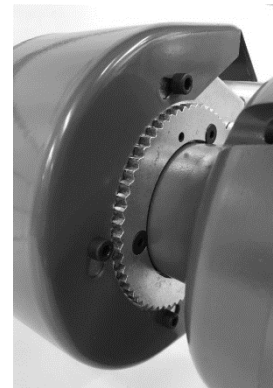

Attach the abrasive disc (C) to the backing plate. Hold firmly for a few seconds to ensure the adhesive activates.

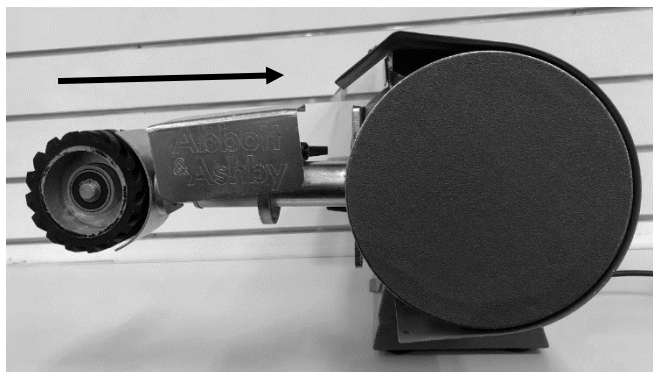

Push against the contact wheel towards the drive pulley to retract the extension arm and place the finishing belt (B) over the main wheel and the contact wheel. Refer to the inside of the belt for the correct installation direction of the belt.

Initially there may be a tightness in this mechanism. This is normal and will improve with use.

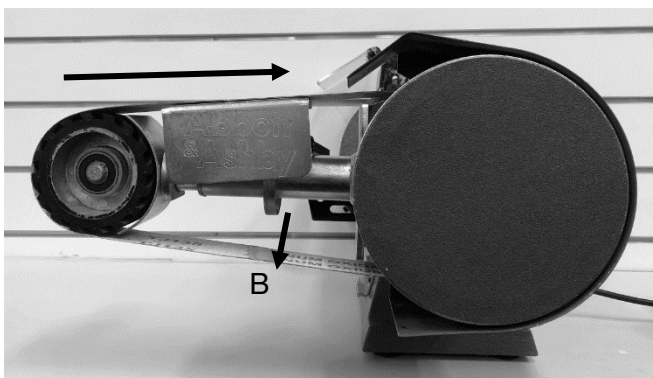

Push against the contact wheel again to extend the extension arm. Ensure the belt is taught and not loose.

Once the belt is on the linisher you can also push down on the bottom of the belt (B) to retract or extend the extension arm.

TRACKING:

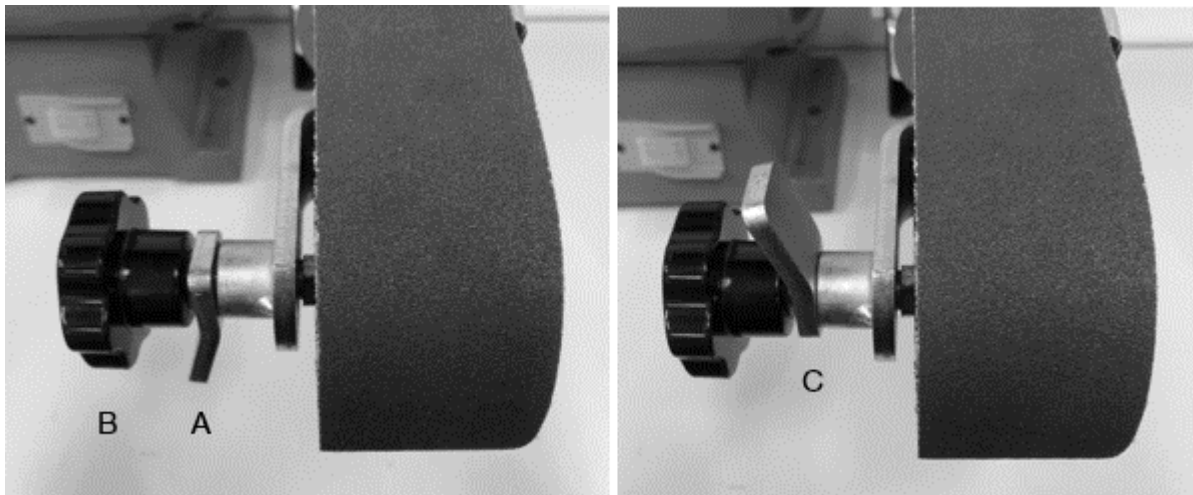

Turn the unit on and inspect the movement of the belt. If adjustments are required move the lever into the loose position (A) To correct any tracking concerns simply turn the knob (B) to adjust the tracking and once adjusted lock the lever gently back into place (C).

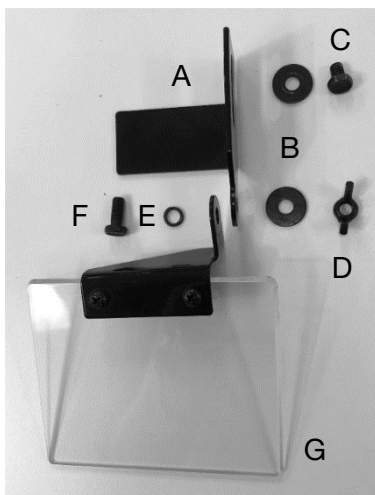

EYESHIELD:

- A) Bracket
- B) 2 x Washers
- C) Short Fastener
- D) Wing Nut
- E) Spring Washer
- F) Long Fastener
- G) Eye Shield

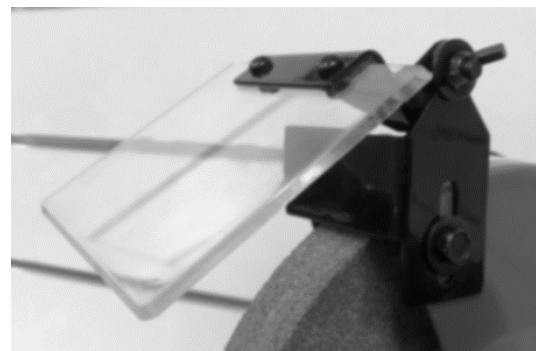

Use the wing nut (D) and 1 x washer (B) secure the eyeshield to the bench grinder allowing no more than 2mm gap between the grinding wheel and bracket (A)

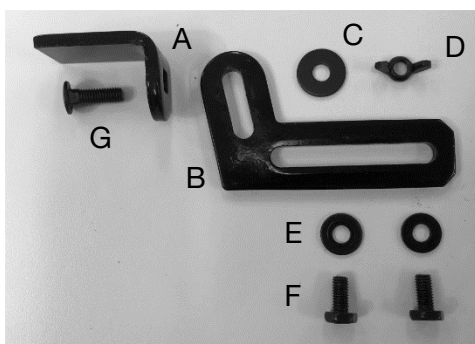

TOOL REST:

- A) Tool Rest
- B) Bracket
- C) 1 x Large Washer
- D) Wing Nut
- E) 2 x Small Washers
- F) 2 x 8mm Fasteners
- G) Long Fastener



Attach the tool rest (A) to the bracket (B) using the long fastener (G) and the Large Washer (C) and wing nut (D). then attach this to the bench grinder using the 2 x small washers (E) and 2 x short fasteners (F), allowing no more than 2mm gap between the grinding wheel and tool rest (A).

MOUNTING:

The grinder can be secured with screws or nuts and bolts to a workbench or pedestal stand. The length of the fasteners will depend on the thickness of the work surface. Where a steel bench is used it is best to mount the grinder to a board, then attach the board to the bench as this will also minimise vibration.

SWITCHING ON AND OFF:

Before connecting to the power supply rotate the wheel by hand to ensure that it is running free from obstruction. Connect to the mains supply and press the rocker switch to the ON position (I). To stop the machine simply press the rocker switch to the OFF position (O).

We also recommend the use of the E-Stop switch ATPED-ESTOP (sold separately)

REPLACING GRINDING WHEEL:

Remove guard by untightening 3 x 6 x 10mm cap screws. Remove 16mm nut and replace wheel. Choose the correct grit to suit your application. Hand spin the wheel to ensure it spins freely and true. Reinstall guards.



WORKING ANGLE ADJUSTMENT:

Loosen the bolt (A) out of the locking position and lift latch (B) to disengage the locking teeth (C); rotate the linisher to the desired angle. Lock the latch back into place firmly into the locking teeth and fasten the bolt to secure the linisher into position.

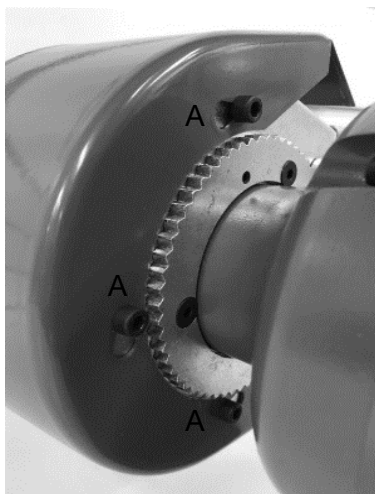

GUARD:

Designed for user ease when changing belts or servicing the unit. No need to remove other components in order to remove the guard. Loosen 3 x cap screw (A), rotate the guard slightly and remove.

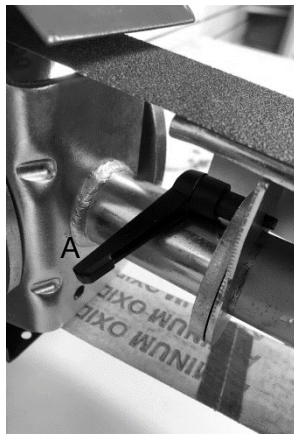
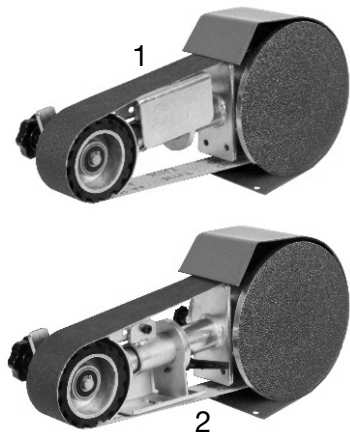

PLATEN:

Platen swivels from under the belt at the top of the linishing attachment (1) to the bottom of the linisher (2).

Turn the lever (A) anti-clockwise to loosen the platen and it can be moved into the desired location and locked back into place by tightening the lever by rotating it clockwise. If required you can lift the lever out of its seat to reset the lever turning position.



POSITIONING:

When purchased on its own the AA362 Linisher can be mounted on either the left or right hand side of the bench grinder to suit your workflow.

There is an additional plate included in the fitting kit that can be installed on the guard to complete the guard when mounted to the left hand side of a bench grinder

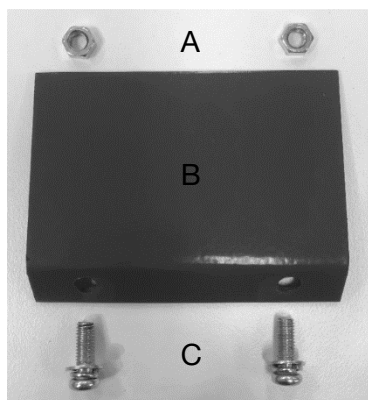

LEFT HAND MOUNT GUARD:

- A) 2 x Nut
- B) Guard Shield
- C) 2 x Retaining fasteners

Only required when the AA362 is mounted to the left hand side of the bench grinder



11. Maintenance



WARNING: REMOVE THE POWER CORD FROM THE POWER SUPPLY BEFORE CARRYING OUT ANY MAINTENANCE

- a. Use a soft dry brush and brush down the body of the unit regularly to ensure there isn't a build of dust and debris on the on the unit.
- b. Remove guards and with a soft dry brush clean the main wheel, extension arm, contact wheel, shaft and inside the guards. Replace the wheel/belt and guards when clean.
- c. Check condition of the wheel, belt and disc, if cracked, torn, worn down or damaged, replace immediately.
- d. Check the condition of the cord to ensure it is not damaged or frayed. As this could cause electrical injuries to the user. If damaged have it repaired by an authorised service agent.
- e. Perform a visual check to ensure tool is functioning as per normal and an audible check for any noise that is not normal. If visual and audible check immediately turn off the tools and contact a relevant repair agent to inspect and service
- f. Regularly check that all the fixing screw, nuts and bolts are tight. They may vibrate loose over time.

16. Warranties – Terms and Conditions

White International Pty Ltd – Abbott & Ashby Linisher AA362 has a 3 Year Limited Product Warranty not including abrasives
White International Pty Ltd – Abbott & Ashby Linisher AA362W6 and AA362W8 have a 5 Year Limited Product Warranty on Motor, electrical switch, device body and guards but not including motor start / run capacitor and provided grinding wheels and abrasives)

This warranty is given in addition to the consumer guarantees found within the Australian Competition and Consumer Act 2010 (Cth) for goods purchased in Australia and the Consumer Guarantees Act 1993 NZ for goods purchased in New Zealand:

This warranty will not apply:

- (i) where this product has been subjected to misuse, abuse, accident or want of care;
- (ii) where this product has been used for a purpose for which it was not designed or is not suited;
- (iii) where the service of this product has been undertaken by a non-authorized person or company or if nonapproved parts have been used;
- (iv) where this product has been used for industrial purposes.

WARRANTY EXCLUSIONS

Wear parts or service related parts required when performing normal and regular maintenance of this product are not covered by warranty unless it is found to be defective by an Authorised Service Centre. These include, but are not limited to: Wheels, Belts and Disc, Contact Wheel

1. White International Pty Ltd / White International NZ Ltd (White International) warrant that all products distributed are free from defects in workmanship and materials, for their provided warranty period as indicated on the top or opposite side of this document. Subject to the conditions of the warranty, White International will repair any defective products free of charge at the premises of our authorised service agents throughout Australia and New Zealand if a defect in the product appears during the warranty period. If you believe that you have purchased a defective product and wish to make a claim under this warranty, contact us on our Sales Hotline on 1300 783 601, or send your claim to our postal address or fax line below and we will advise you as to how next to proceed. You will be required to supply a copy of your proof of purchase to make a claim under this warranty.
2. This warranty excludes transportation costs to and from White International or its appointed service agents and excludes defects due to non-compliance with installation instructions, neglect or misuse, inadequate protection against the elements, low voltage or use or operation for purposes other than those for which they were designed. For further information regarding the suitability of your intended application contact us on our Sales Hotline on 1300 783 601. If you make an invalid claim under this warranty, the original product will be sent back to you unrepaid.
3. This warranty refers only to products sold after the 1st January 2012, and is not transferable to another product type and only applies to the original owner, purchaser or end user, and is in addition to the consumer guarantees found within the Competition and Consumer Act 2010 (Cth) for goods purchased in Australia and the Consumer Guarantees Act 1993 (NZ) for goods purchased in New Zealand.
4. Our goods come with guarantees that cannot be excluded under the Australian Consumer Law. You are entitled to a replacement or refund for a major failure and for compensation for any other reasonably foreseeable loss or damage. You are also entitled to have the goods repaired or replaced if the goods fail to be of acceptable quality and the failure does not amount to a major failure.
5. To the fullest extent permitted by law, White International excludes its liability for all other conditions or warranties which would or might otherwise be implied at law. To the fullest extent permitted by law, White International's liability under this warranty and any other conditions, guarantees or warranties at law that cannot be excluded, including those in the Competition and Consumer Act 2010 (Cth), is expressly limited to:
 - a. in the case of products, the replacement of the product or the supply of equivalent product, the payment of the cost of replacing the product or of acquiring an equivalent product or the repair of the product or payment of the cost of having the product repaired, is at the discretion of White International or a 3rd party tribunal elected under the Competition and Consumer Act 2010 (Cth) for goods purchased in Australia and the Consumer Guarantees Act 1993 (NZ) for goods purchased in New Zealand; and
6. To the fullest extent permitted by law, this warranty supersedes all other warranties attached to the product or its packaging.
7. In the case of services, supplying the services again or the payment of the cost of having the services supplied again, is at the discretion of White International or a 3rd party tribunal elected under the Competition and Consumer At 2010 (Cth) for goods purchased in Australia and the Consumer Guarantees Act 1993 (NZ) for goods purchased in New Zealand.
8. Our warranty commences from the date of purchase of the above mentioned tool. Proof of purchase is required before consideration under warranty is given. Record your date of purchase in the space below and retain this copy for your records.

The White International Policy is one of continuous improvement and the company reserves the right to alter designs, colours and specifications without notice.

The Abbott & Ashby logo is a registered trademark of White International Pty Ltd.

Record your date of purchase in the space below and retain this copy for your records.

Date of Purchase**Model Purchased**